

**Model 73024
MMCX PLUG STRAIGHT CRIMP, RG178**

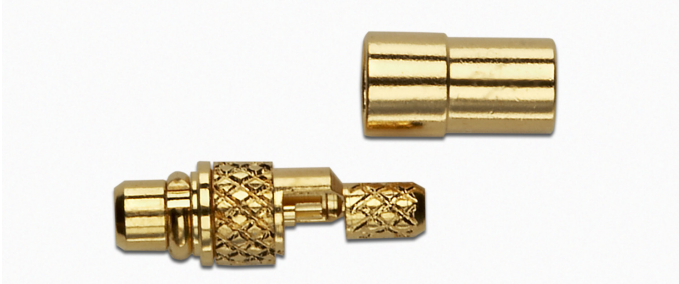

Model 73024 MMCX PLUG STRAIGHT CRIMP, RG178

Snap-on coupling and micro-miniature size for fast connect and disconnect where space is limited

Features

- DC - 3 GHz bandwidth.
- 50% smaller than MCX connectors.
- Connectors allow rotation of 360° for layout flexibility.
- Non-slotted contact design for low RF leakage.
- Meets CECC 22340.
- Perfect for applications where space, weight, performance and ease of assembly are required.

Materials

- Body is machined brass with gold plating.
- Center contacts – Plug is gold plated Phosphor bronze and Jack is gold plated beryllium copper.
- High quality PTFE insulators.
- Crimp Ferrules are gold or nickel plated copper.

Ordering Information

Model: 73024
Description: MMCX PLUG STRAIGHT CRIMP, RG178

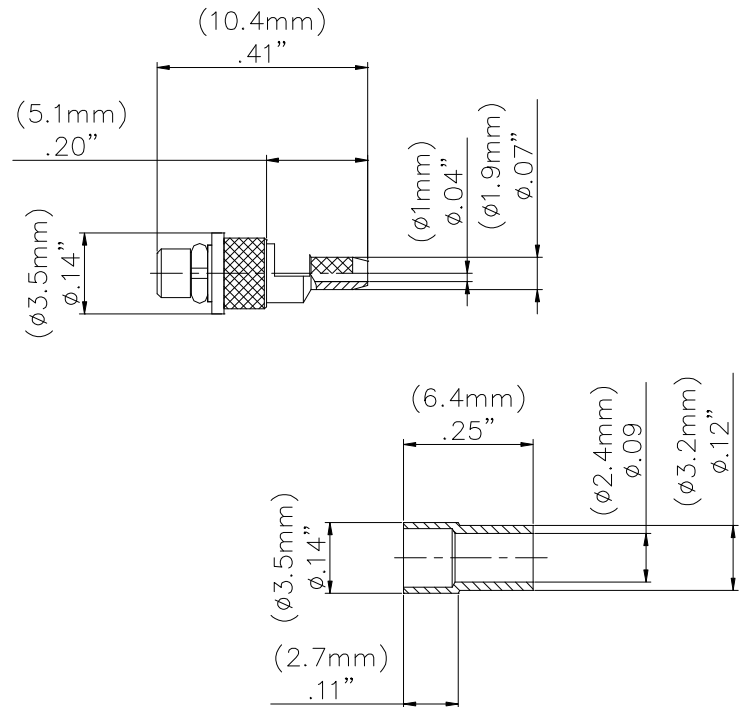

Specifications

Impedance	50 Ω
Frequency Range	DC - 3 GHz
Working Voltage	170 Vrms max.
Dielectric Withstanding Voltage	500 Vrms
VSWR	1.35 max
Center / Outer contact resistance	10 / 5 mΩ
Number of insertions	500 cycles minimum
Insulation resistance	> 500 MΩ
Temperature Range	-55° C to 155° C, -67° F to 311° F

USA: Sales: 800-490-2361
Technical Support: technicalsupport@pomonatest.com
Fax: 425-446-5844

Europe: 31-(0) 40 2675 150 International: 425-446-5500

Where to Buy: www.pomonaelectronics.com

All dimensions are in inches. Tolerances (except noted): .xx = ±.02" (.51 mm), .xxx = ±.005" (.127 mm). All specifications are to the latest revisions. Specifications are subject to change without notice. Registered trademarks are the property of their respective companies.
D2003384 REV 001

**Model 73024
MMCX PLUG STRAIGHT CRIMP, RG178**

Cable Types and Crimp Die Information

Connector Model #	Cable Groups	Crimp Die Cavity Size for Outer Ferrule
73024	RG178	.105 (2.67)

Cable Assembly Instructions

1. CUT CABLE END EVENLY AND PERPENDICULAR

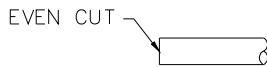

2. SLIDE OUTER FERRULE OVER CABLE END.

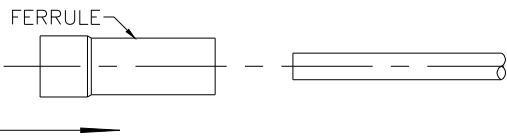

3. STRIP CABLE JACKET, BRAID, AND DIELECTRIC TO SPECIFICATION LENGTHS.

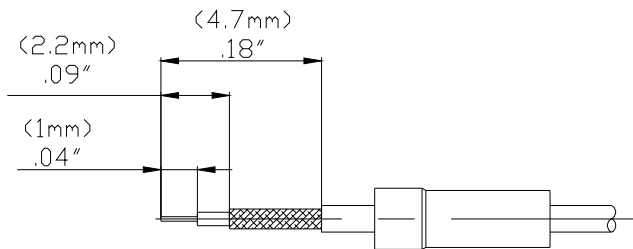

RECOMMENDED STRIP LENGTHS

4. FLARE BRAID END SLIGHTLY.

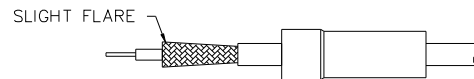

5. SLIDE CONNECTOR BODY OVER CENTER CONDUCTOR.

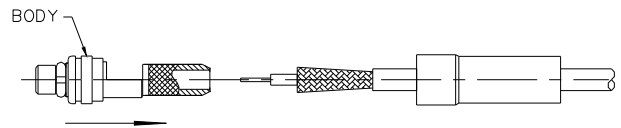

6. SLIDE OUTER FERRULE OVER BRAID AND UP AGAINST BODY ASSEMBLY.

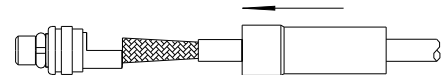

7. CRIMP OUTER FERRULE WITH APPROPRIATE CRIMP TOOL.

